

Features

- Uses PingWei advanced PerfectMOS2 technology
- Extremely low on-resistance $R_{DS(on)}$
- Excellent $Q_g \times R_{DS(on)}$ product(FOM)
- Qualified according to AEC-Q101 criteria

Benefits

- High robustness and reliability
- Increases maximum current capability
- Low power loss, high power density
- Easy paralleling

Applications

- General automotive applications
- EPS(Electric Power Steering)
- DC-DC



100% DVDS Tested
100% Avalanche Tested

Product Summary

V_{DS}	40V
$R_{DS(on)}@10V$ typ	0.64mΩ
I_D (Silicon limit)	348A

UPDFN5*6 Double Cooling

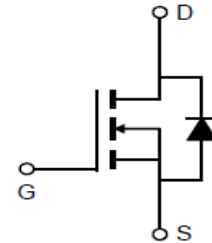
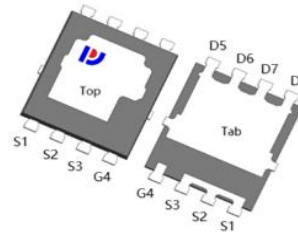

Package Marking and Ordering Information

Part #	Marking	Package	Packing	Reel Size	Tape Width	Qty
PWDC008N04UESQ	PW0804U	UPDFN5*6 Double Cooling	Tape&Reel	13 inches	12mm	5000pcs

Absolute Maximum Ratings

Parameter	Symbol	Value	Unit
Drain-source voltage	V_{DS}	40	V
Continuous drain current	I_D	348	A
$T_C = 25^\circ\text{C}$ (Silicon limit)		246	
$T_C = 100^\circ\text{C}$ (Silicon limit)		175	
$T_C = 100^\circ\text{C}$ (Package limit)		46	
$T_a = 25^\circ\text{C}$ (See RthJA)			
Pulsed drain current ($T_C = 25^\circ\text{C}$)	$I_{D\ pulse}$	700	A
Avalanche energy, single pulse ($L=0.1\text{mH}$)	E_{AS}	435	mJ
Gate-Source voltage	V_{GS}	± 20	V
Power dissipation	P_{tot}	171	W
$T_C = 25^\circ\text{C}$		3.0	
$T_a = 25^\circ\text{C}$ (See RthJA)			
Operating junction and storage temperature	T_j, T_{stg}	-55...+175	$^\circ\text{C}$
Reflow soldering temperature (10s)	T_{sold}	260	$^\circ\text{C}$

Thermal Resistance

Parameter	Symbol	Value			Unit	Test Condition
		min.	typ.	max.		
Thermal resistance, junction - case.	RthJC	-	0.75	0.9	°C/W	-
Thermal resistance, Channel to Top Plate	Rth(ch-tp)	-	-	0.95	°C/W	Note1
Thermal resistance, junction - ambient	RthJA	-	-	49.5	°C/W	Note2

Electrical Characteristic (at Tj = 25 °C, unless otherwise specified)

Parameter	Symbol	Value			Unit	Test Condition
		min.	typ.	max.		

Static Characteristic

Drain-source breakdown voltage	BV _{DSS}	40	-	-	V	V _{GS} =0V, I _D =250uA
Gate threshold voltage	V _{GS(th)}	2.0	-	3.0	V	V _{DS} =V _{GS} , I _D =250uA
Zero gate voltage drain current	I _{DSS}	-	-	1	μA	V _{DS} =40V, V _{GS} =0V T _j =25°C T _j =150°C
Gate-source leakage current	I _{GSS}	-	-	±100	nA	V _{GS} =±20V, V _{DS} =0V
Drain-source on-state resistance	R _{DS(on)}	-	0.64	0.79	mΩ	V _{gs} =10V, I _d =30A
Transconductance	g _{fs}	-	257	-	S	V _{DS} =5V, I _D =50A

Dynamic Characteristic

Input Capacitance	C _{iss}	-	7282	-	pF	V _{GS} =0V, V _{DS} =20V, f=300KHz
Output Capacitance	C _{oss}	-	2318	-		
Reverse Transfer Capacitance	C _{rss}	-	55	-		
Gate Total Charge	Q _G	-	100	-	nC	V _{ds} =20V, I _d =30A, V _{gs} =10V
Gate-Source charge	Q _{gs}	-	33	-		
Gate-Drain charge	Q _{gd}	-	12	-		
Turn-on delay time	t _{d(on)}	-	20	-	ns	V _{GS} =10V, V _{DD} =20V, R _{G_ext} =1.6Ω, I _D =20A
Rise time	t _r	-	23	-		
Turn-off delay time	t _{d(off)}	-	68	-		
Fall time	t _f	-	50	-		
Gate resistance	R _G	-	2.7	-	Ω	V _{GS} =0V, V _{DS} =0V, f=1MHz



Body Diode Characteristic

Parameter	Symbol	Value			Unit	Test Condition
		min.	typ.	max.		
Body Diode Forward Voltage	V_{SD}	-	-	1.2	V	$V_{GS}=0V, I_{SD}=30A$
Body Diode Continuous Forward Current	I_S	-	-	175	A	TC = 25°C
Body Diode Pulsed Current	I_S pulse	-	-	700	A	TC = 25°C
Body Diode Reverse Recovery Time	t_{rr}	-	130	-	ns	$I_F=30A,$ $dI/dt=100A/\mu s$
Body Diode Reverse Recovery Charge	Q_{rr}	-	300	-	nC	

Note 1: A maximum of the $R_{th}(ch-tp)$ measured at Pingwei's test environment is only used for reference. Be aware that the top-plate has the same electric potential as the sources; however, not intended for an Electrode.

Note 2: 27mm x 20mm x 1.6mm FR-4, 1oz, 1 layer PCB, Top plate has no heatsink.

Typical Performance Characteristics

Fig 1: Output Characteristics

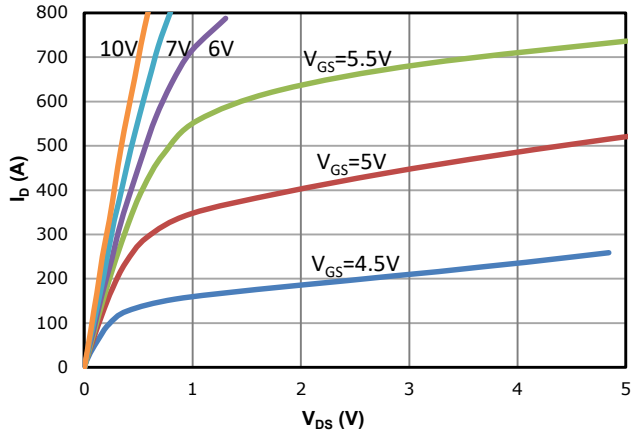

Fig 2: Transfer Characteristics

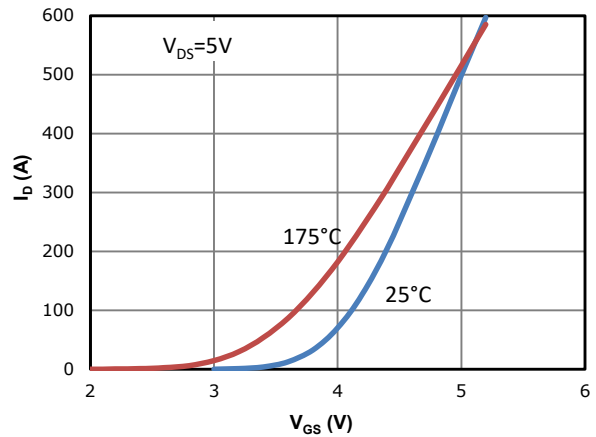

Fig 3: $R_{DS(on)}$ vs Drain Current and Gate Voltage

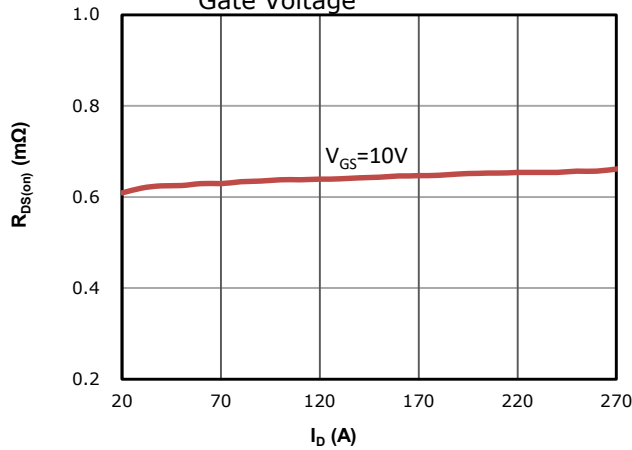

Fig 4: $R_{DS(on)}$ vs Gate Voltage

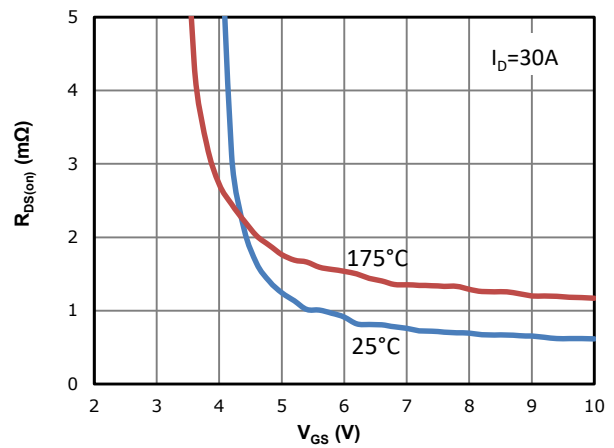

Fig 5: $R_{DS(on)}$ vs. Temperature

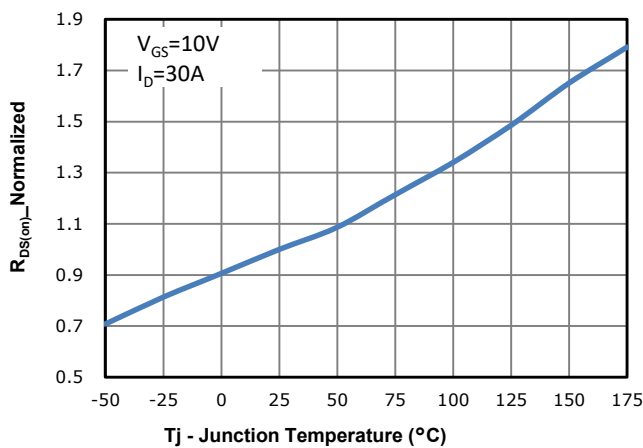

Fig 6: $V_{GS(th)}$ vs. Temperature

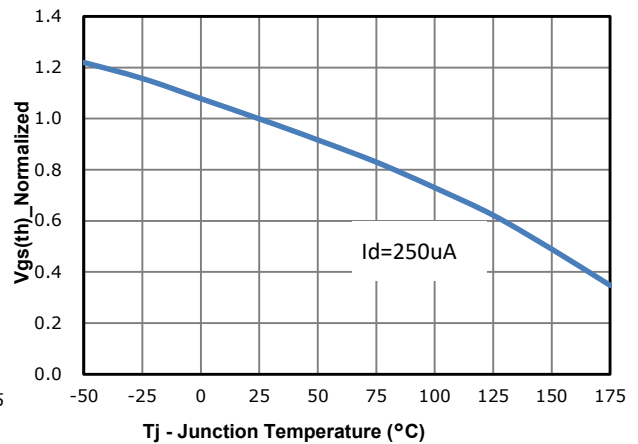

Fig 7: BVdss vs. Temperature

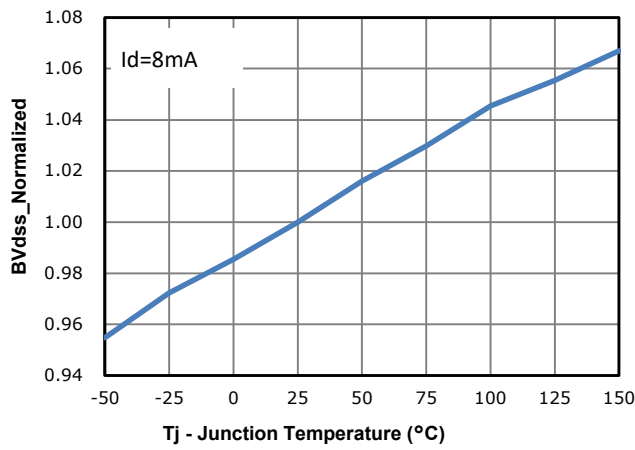

Fig 8: Capacitance Characteristics

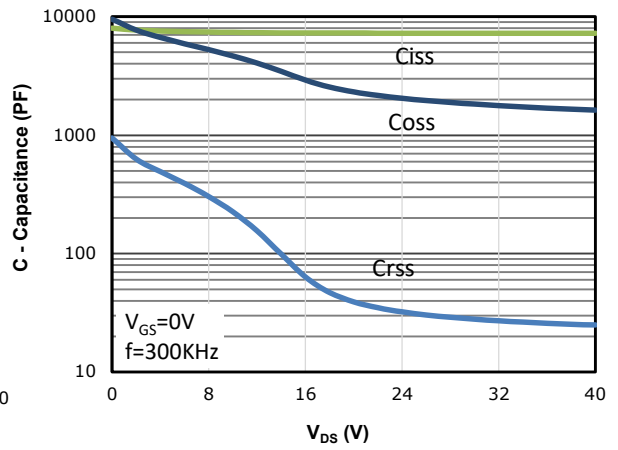

Fig 9: Gate Charge Characteristics

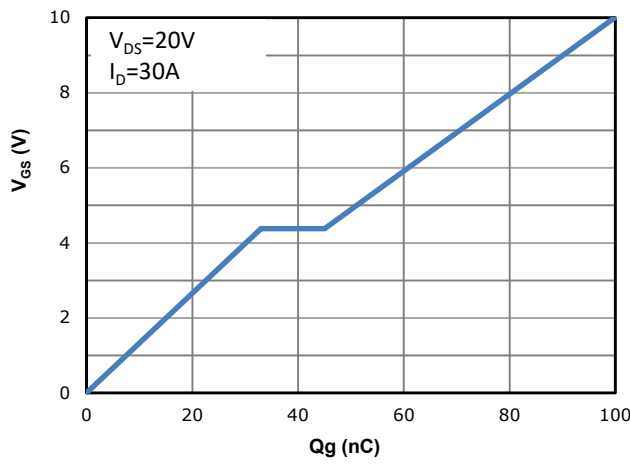

Fig 10: Body-diode Forward Characteristics

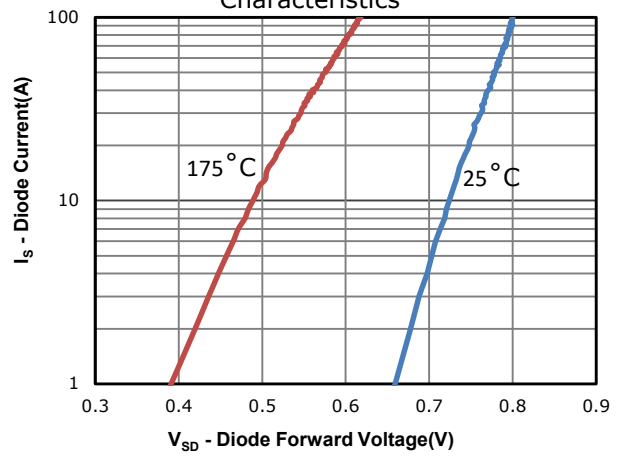

Fig 11: Power Dissipation

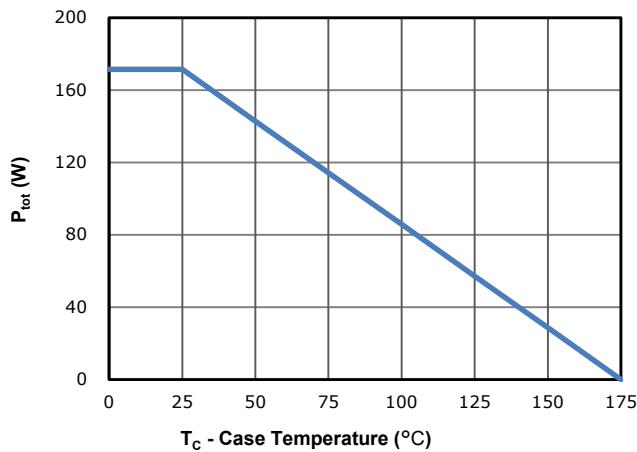

Fig 12: Drain Current Derating

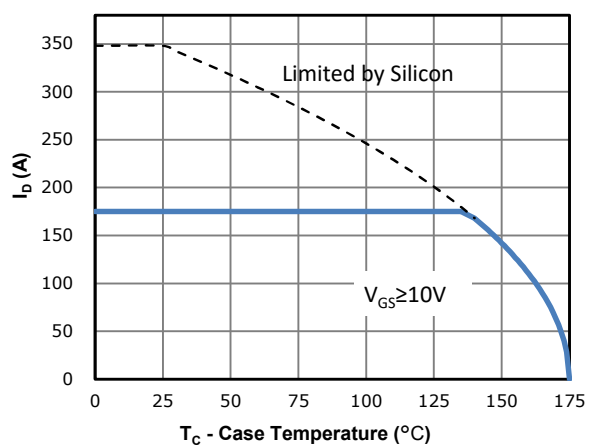

Fig 13: Safe Operating Area

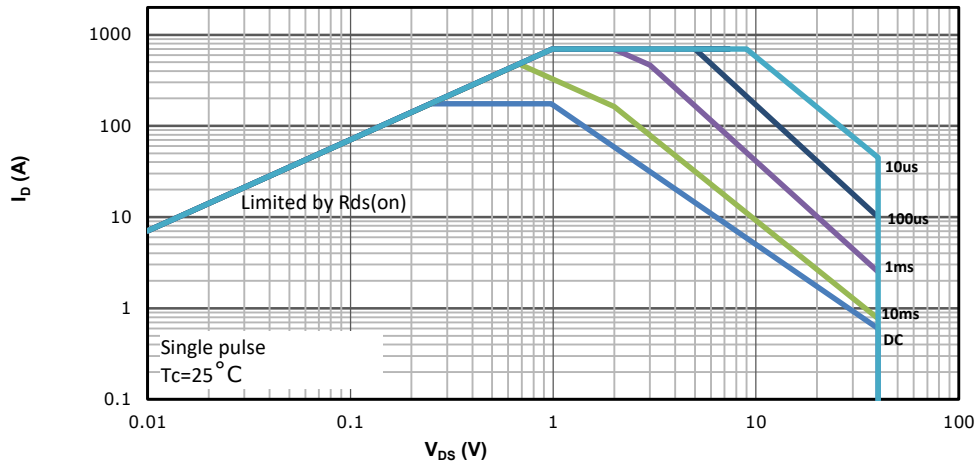
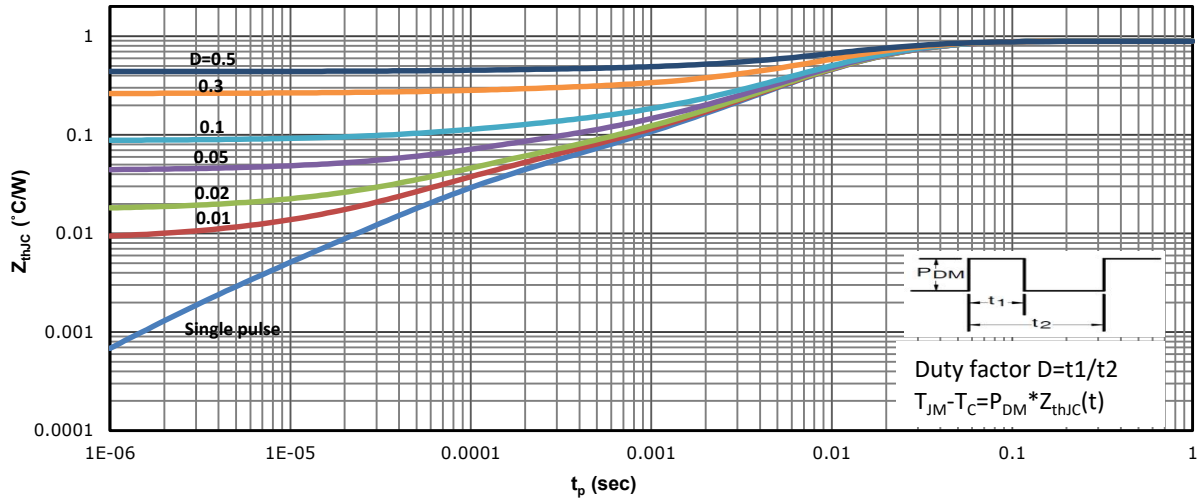
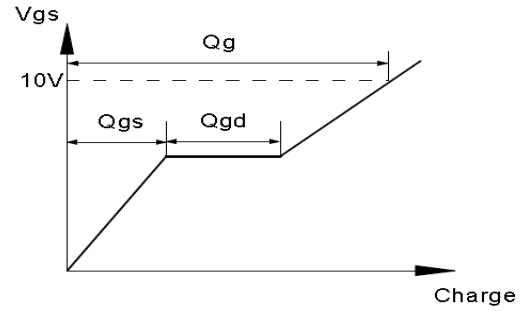
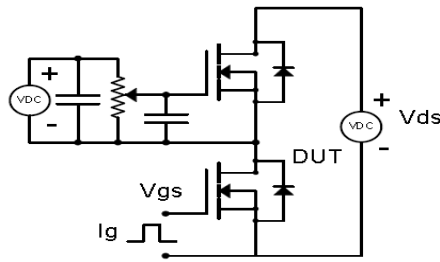

Fig 14: Max. Transient Thermal Impedance



Test Circuit & Waveform

Gate Charge Test Circuit & Waveform



Resistive Switching Test Circuit & Waveforms

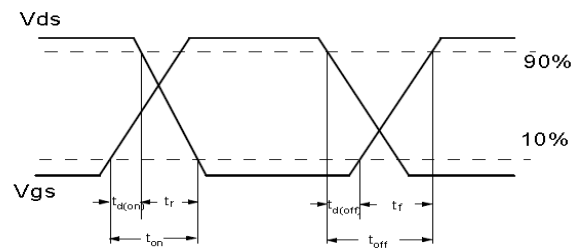
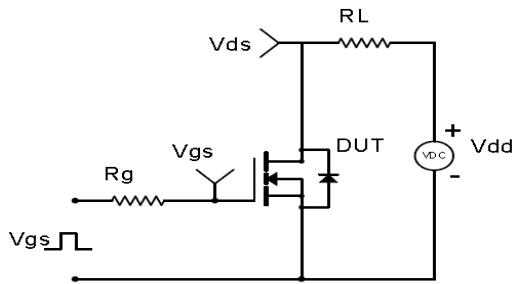

Unclamped Inductive Switching (UIS) Test Circuit & Waveforms

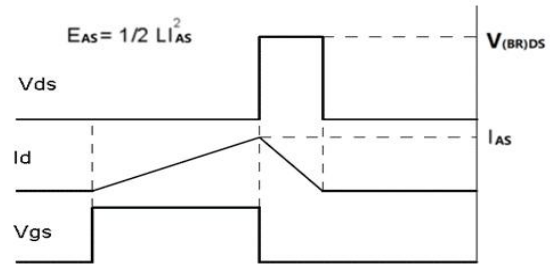
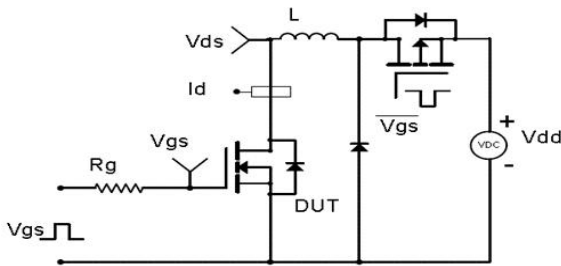

Diode Recovery Test Circuit & Waveforms

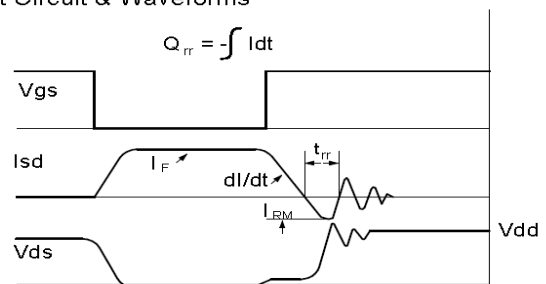
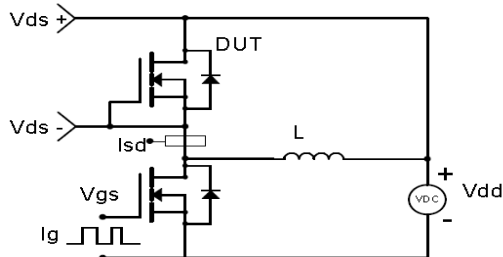

UPDFN5*6 Double Cooling

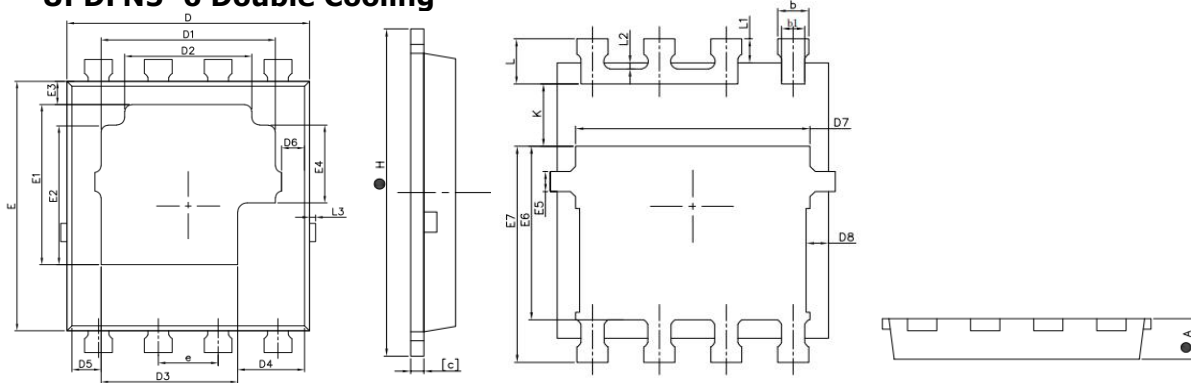

SYMBOL	MILLIMETERS		INCHES	
	MIN	MAX	MIN	MAX
A	0.75	0.95	0.030	0.037
b	0.49	0.69	0.019	0.027
b1	0.34	0.54	0.013	0.021
c	0.20	0.30	0.008	0.012
D	4.95	5.35	0.195	0.211
D1	3.45	3.95	0.136	0.156
D2	2.45	2.95	0.096	0.116
D3	2.65	3.15	0.104	0.124
D4	1.17	1.67	0.046	0.066
D5	0.37	0.87	0.015	0.034
D6	0.29	0.69	0.011	0.027
D7	4.45	4.85	0.175	0.191
D8	0.23	0.63	0.009	0.025
E	5.28	5.68	0.208	0.224
E1	3.27	3.77	0.129	0.148
E2	2.80	3.30	0.110	0.130
E3	0.50	1.10	0.020	0.043
E4	1.46	1.96	0.057	0.077
E5	0.25	0.60	0.010	0.024
E6	3.20	3.70	0.126	0.146
E7	4.05	4.55	0.159	0.179
e	1.27		0.050	
H	6.19	6.69	0.244	0.263
L	0.65	1.15	0.026	0.045
L1	0.28	0.68	0.011	0.027
L2	0.12		0.005	
L3	-	0.23	-	0.009
K	1.04	1.44	0.041	0.057



Revision History

Revision	Date	Major changes
1.0	2024/10/15	Release of Formal Version.
1.1	2024/12/6	Update package ID limit from 150A to 175A;
1.2	2025/1/7	Update Outline D7 from 4.25-4.65 to 4.45-4.85,E3 from 0.26-0.76 to 0.5-1.1;
1.3	2025/3/17	Update Rjc & Zth & SOA;

Disclaimer

Any and all semiconductor products have certain probability to fail or malfunction, which may result in personal injury, death or property damage. Customer are solely responsible for providing adequate safe measures when design their systems.

The product is not intended for use in applications that require extraordinary levels of quality and reliability, such as aviation/aerospace and life-support devices or systems.

Buyer is responsible for its products and applications using PingWei products, including compliance with all laws, regulations and safety requirements or standards, regardless of any support or applications information provided by PingWei.

“Typical” parameters which may be provided in PingWei data sheets and/or specifications can and do vary in different applications and actual performance may vary over time. All operating parameters, including “Typicals” must be validated for each customer application by customer’s technical experts

ALL PRODUCT, PRODUCT SPECIFICATIONS AND DATA ARE SUBJECT TO CHANGE WITHOUT NOTICE TO IMPROVE RELIABILITY, FUNCTION OR DESIGN OR OTHERWISE